

JETCENTRAL

MINIATURE JET ENGINES FOR THE SERIOUS FLYER

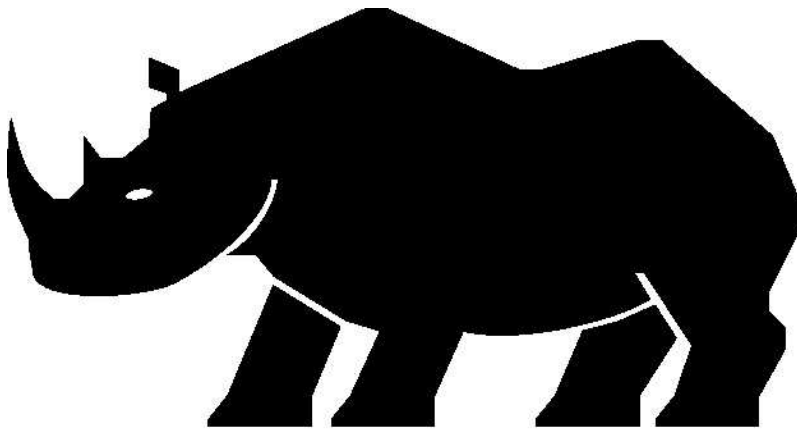
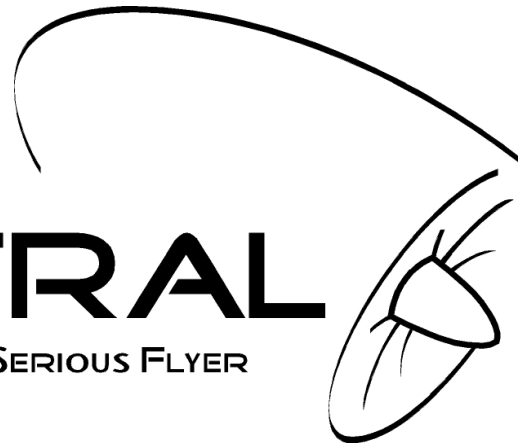

RHINO

TITANIUM Series

OPERATION AND MAINTENANCE MANUAL

INTRODUCTION

JET CENTRAL produces the most advanced micro turbines available today: smaller, more powerful, faster acceleration, less fuel burn, lower temperatures, higher quality, less maintenance and the best price. **JET CENTRAL**, an ISO 9000 Company is a full production engine manufacturer, producing high quality parts to be assembled into the newest line of micro turbines....

We are committed to our turbines in a way never seen before. You won't find a more knowledgeable company in micro turbines to turn than to **JET CENTRAL**.

TABLE OF CONTENTS

1 SAFETY INFORMATION	3
1.1 SAFETY RULES.....	5
2 TURBINE SYSTEM COMPONENTS DESCRIPTION.....	6
2.1 PARTS LIST.....	6
2.2 TURBINE.....	7
2.3 I.C.S.....	8
2.4 FUEL / OIL SYSTEM.....	9
2.5 STARTING GAS SYSTEM	9
2.6 HAND DATA TERMINAL(HDT)	9
3 TURBINE SYSTEM INSTALLATION INSTRUCTIONS.....	10
3.1 I.C.S.....	10
3.2 PUMP/STARTER BATTERY	11
3.3 RADIO RECEIVER	11
3.4 THERMOCOUPLE	11
3.5 FUEL LINE	12
3.6 STARTING GAS	13
3.7 RPM SENSOR.....	13
3.8 TURBINE SERVICE LINES DESCRIPTION	13
4 PROGRAMMING THE I.C.S.	18
4.1 FIRST SCREEN	18
4.2 MAIN SCREEN	18
4.3 SECONDARY SCREEN	19
4.4 MENU SCREEN.....	19
4.5 START SUBMENU.....	20
4.6 INFO SUBMENU	21
4.7 RADIO SUBMENU	23
4.8 RUN SUBMENU.....	26
4.9 LAST RUN SHUTDOWN REASON	27
5 RADIO LINK FAILSAFE.....	28
6 ADVANCED PROGRAMMING	29
7 STARTING THE ENGINE	31
8 PROPER RANGE CHECKING	33
9 FUEL AND FUEL SYSTEM CARE.....	34
10 MULTIENGINE INSTALLATION.....	35
11 MAINTENANCE	36
12 TROUBLESHOOTING	37
13 IMPORTANT UPDATES	39
14 ECU LEARNING PROCEDURE.....	40
15 WORLDWIDE SERVICE	41
LIFETIME TURBINE WARRANTY	43

1 Safety Information

The **JET CENTRAL TURBINE ENGINES** are in its own right a single stage centrifugal flow gas turbine engine, configured to operate as a **TURBOJET ENGINE** for use mainly, but not exclusively, in remotely piloted fixed wing aircraft. Such aircraft and their control systems must be appropriately designed and constructed to be compatible with the performance of the **TURBOJET ENGINE**.

NOTE: *The airworthiness, structural design, integrity of the aircraft and its control systems are the entire responsibility of the owner/builder/operator. JET CENTRAL and its agents cannot accept responsibility for any failure, structural or otherwise, of the aircraft or its control systems. JET CENTRAL and its agents cannot accept responsibility for any inappropriate or unauthorized use of the JET CENTRAL ENGINE.*

The **JET CENTRAL** gas turbine engine is a very safe, easy to operate unit. The **JET CENTRAL** is a state of the art gas turbine engine and all components are manufactured within the highest standards. If operated correctly it will provide years of reliable, trouble-free service, with low maintenance.

It cannot however, be stressed highly enough, that the operating instructions be fully understood before attempting to operate your engine. Any alterations to the engine whatsoever, without the written consent of JET CENTRAL, will render any warranty null and void and as a consequence the controlling body in your country may not grant approval for use.

The **JET CENTRAL** gas turbines are high performance **TURBOJET ENGINES** that need discipline, commitment to correct and safe operation. With other persons present while operation, the **TURBOJET ENGINE ALWAYS ENFORCE THE PROPER SAFE DISTANCES FROM THE TURBINE!**

The recommended minimum safe distances are:

In front of the turbine: 15 feet

Beside of the turbine: 25 feet

Behind the turbine: 25 feet

Fire extinguishers should be on hand at all times. **JC** recommends CO₂ variety. To avoid hearing damage, always use hearing protection when near a running turbine engine. When the turbine is running never place your hands closer than 6 inches into the area of the intake.

An EXTREME SUCTION, which can grasp a hand, fingers or other objects in a flash, prevails in this area. Be aware of this danger always!

Prevent foreign materials from entering the intake when working the turbine. Before operation, make sure there are no loose parts or debris near the turbine. Objects being sucked in can cause severe damage.

Always exercise caution around the hot parts of the turbine, to avoid burns. The outer case at the turbine stage and nozzle reaches 400 - 500°C (750 - 950 °F), while the exhaust gas may exceed 600° C (1290 °F).

Assure that the fuel is mixed with the correct amount of synthetic oil for the specific engine.
Use only synthetic turbine oils always.

Use common sense when operating model turbine jet aircraft. Never operate in or around heavily populated areas, and in or around areas experiencing drought or dryness.

1.1 Safety Rules

- Rule 1** **Never run your engine indoors; always ensure you are in the open air.**
Ensure non-associated persons are at least 9 meters (10 yards) away from the engine when running. Always have a fully operational CO₂ fire extinguisher available and ready for use when starting and running your engine.
- Rule 2** When bench running or engine starting in an airframe; never allow yourself or another person to stand behind or in the rear quadrant of the engine. Always ensure the exhaust of the engine is directed away from persons and property as the heat of the engine exhaust can cause damage and injury.
- Rule 3** Air will save the engine, in the event of a hot or failed start always isolate the fuel to the engine, but always keep the start air running to the engine, this will clear the engine of residual fuel and will keep the core of the engine cool. If you are using the Electric starter, once again isolate the fuel supply to the engine and keep the starter running. Do not be afraid to use your fire extinguisher, a CO₂ extinguisher will not harm the engine in any way. A hand held blower is another good safety item to have on hand during the start up and shut down of the motor.
- Rule 4** Never attempt to start a flooded or wet engine, this will result in a hot or wet start and you will have flames. To dry out or clear the engine, stand it tail pipe down and either run the starter motor or blow air through the engine until all residual fuel has been blown out of it.
- Rule 5** Always start the engine with the nose of the plane pointed into the wind and shut down with the nose pointed into the wind also.
- Rule 6** In the event of a hot start, or sever engine fire, close the throttle and the trim lever to the fully back position and turn off the fuel isolation valve, this will allow the engine to clear itself, be ready to use your fire extinguisher. A CO₂ type extinguisher will not harm the engine in any way; if a dry powder extinguisher is used and the powder is ingested into the engine then you must return the engine to our service department.

2 Turbine System Components Description

2.1 Parts List

Before starting installation of the engine please check the contents against the parts list. If any part is missing or damaged, contact **JET CENTRAL** or their agent in your country for correction. **DO NOT** substitute missing or damaged parts as this will void your warranty and your country's controlling body's approval for use.

- 1 - Turbine Engine
- 1 - I.C.S. Unit
- 1 - Clear Fuel Line 6mm.
- 1 - Clear Fuel Line 4mm.
- 1 - Yellow Fuel Line 4mm.
- 1 - Battery Pack
- 1 - Hand Data Terminal (HDT)
- 2 - Plug 4mm.
- 1 - Air Trap Tank
- 1 - Manual



Box #1 with:

- 1 - Fuel Pump
- 1 - Glow Plug Connector
- 2 - Solenoid Valves
- 1 - Nylon Strap
- 1 - Fuel Pump Mount

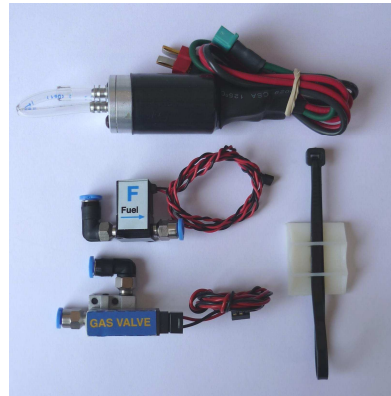

Box #2 with:

- 1 - Gas Tank with Festo "T" Connector
- 1 - On/Off Festo Valve 6mm.
- 2 - Straight Festo Connectors
- 2 - One Way Festo Connectors
- 1 - Gas Restrictor
- 1 - Gas Filter
- 1 - Fuel Filter
- 1 - Extension Cable
- 2 - JR Extension

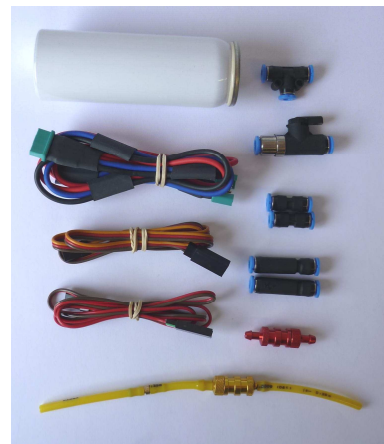

2.2 Turbine

It is a single shaft turbojet with an annular combustor. A single stage axial flow turbine drives a single stage centrifugal compressor. The shaft is supported by 2 fuel/oil lubricated pre-loaded angular contact bearings. The turbine speed is controlled by the amount of fuel received from the fuel pump, which is controlled by the **I.C.S.**

Turbine Specifications

	Bee II	Rabbit	Cheetah	Rhino	Mammoth
Thrust Class	7 Kg (15.5 Lbs) @185,000 RPM	8.6 Kg (19 Lbs) @152,000 RPM	14 Kg (31 Lbs) @ 130,000 RPM	16.3 Kg (36 Lbs) @ 117,000 RPM	21.5 Kg (48 Lbs) @ 104,000 RPM
Full Throttle Fuel Consumption	0.24 Lt/min (8.1 Oz/min)	0.31 Lt/min (10.4 Oz/min)	0.47 Lt/min (16 Oz/min)	0.52 Lt/min (17.5 Oz/min)	0.70 Lt/min (23 Oz/min)
R.P.M. range	55,000-185,000	40,000-152,000	35,000-130,000	30,000-117,000	28,000-104,000
E.G.T.	500°C - 700°C (932 -1292°F)	500°C - 700°C (932 -1292°F)	500°C - 700°C (932 -1292°F)	500°C - 700°C (932 -1292°F)	500°C - 700°C (932 -1292°F)
Weight	0.880 Kg (1.94 Lbs) with starter	1.0 Kg (2.2 Lbs) with starter	1.360 Kg (3 Lbs) with starter	1.700 Kg (3.75 Lbs) with starter	2.240 Kg (4.9 Lbs) With starter
Diameter	82 mm (3.228 inches)	91 mm (3.582 inches)	102 mm (4 inches)	111 mm (4.37 inches)	124 mm (4.881 inches)
Length	232 mm (9.13 inches)	245 mm (9.645 inches)	250 mm (9.842 inches)	300 mm (11.8 inches)	349 mm (13.74 inches)

2.3 I.C.S.

The **I.C.S.** (intelligent Control System) is a total system for the control of a model gas turbine engine. Its main function is to control and regulate the fuel pump, providing to the turbine engine the necessary amount of fuel for safe and controlled operation.

The **I.C.S.** measures the exhaust gas temperature, the relative position of the throttle stick and the rotor speed. It monitors all of the controls necessary to guarantee that the engine stays between the user-defined parameters of operation, also providing fail-safe shutdown of the engine when it has detected any important anomaly. In order to make this assessment, the **I.C.S.** has a rpm sensor, a thermocouple input, a throttle servo input, power connections for the fuel pump, starter, glow plug, fuel and gas valves, battery and a digital (RS232) serial port to program and read the data in real-time to a PC.

The measurements made by the I.C.S. are:

- Temperature of the exhaust gas
- Pump battery voltage
- Width of the throttle pulses from the radio transmitter
- Engine rotor RPM
- Engine run time
- External analog signal

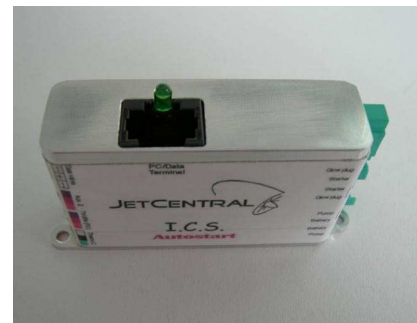

All of these measurements can be read into and displayed on the Hand Data terminal (HDT) that is connected to the **I.C.S.** by a RJ-45 connector, or into a personal computer through a RS232 adapter. The configuration/setup parameters are stored in the **I.C.S.** by the HDT or the PC.

Features:

- RPM input: Magnetic sensor up to 250.000 R.P.M.
- Temperature range up to 1000°C using a "K" type thermocouple
- PWM control of 8192 steps for pump
- Build-in electronic brake for the starter motor to help the clutch to disengage
- Blown glow-plug detector
- Adjustable glow-plug power
- Adjustable gas flow
- Elapsed engine run timers
- Status LED on the unit plus 2 more remote on option
- RS232 interface to interface to a PC
- Black box function. Record the engine measures each 0.5 sec up to 51 minutes
- Used mAh counter
- Bad RC pulses (glitches) counter

2.4 Fuel / Oil System

The Fuel/Oil is pre mixed together. Where the fuel line connects to the motor a T-fitting sends some of the Fuel/Oil to the bearings and the rest is sent to the fuel nozzles in the combustion chamber. It is important to filter the fuel and use proper types of fuel in the turbine Engine. Without proper filtering one or more of the injector needles could become clogged, thus affecting the proper running of the engine. Only synthetic turbine engine oil is to be used and MIXED TO THE PROPER AMOUNT of 2.5% or 16 US ounces per 5 US gallons fuel.

2.5 Starting Gas System

In the initial start sequence, the motor uses propane or a propane/butane mixture. This system uses an onboard gas tank and a solenoid valve to deliver the gas to the combustion chamber, the glow plug is powered momentary to cause ignition. When certain parameters are met the fuel solenoid valve is opened by the **I.C.S.** and then fuel is used to bring the engine to the proper idle RPM during the remaining ramps. The gas valve is automatically closed when a certain RPM is reached during the fuel ramp.

2.6 Hand data Terminal (HDT)

The Hand Data Terminal is simple and easy to operate. The HDT is used to read the different information and to program certain parameters in the **I.C.S.**, this is a link between the user and the **I.C.S.** Make sure to take the necessary time and learn the operation, as this is the only exact way the operator can monitor and check that the turbine is running properly. The unit is small and compact, but always remove it before flying.

Note: If you leave it installed, remember it uses power from your RX battery.

HDT

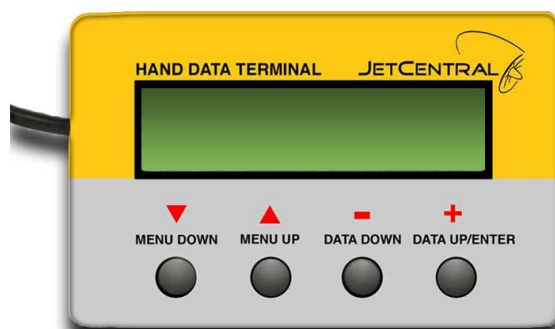

3 Turbine System Installation Instructions

3.1 I.C.S.

Connections:

- Throttle input to the receiver: JR type servo cable (Throttle RX)
- Propane/butane valve: JR type connector receptacle (Gas Valve)
- Fuel valve: JR type connector receptacle. The central cable is positive and the two of the sides negative (Fuel Valve)
- RPM sensor: JR type connector receptacle (RPM Sensor)
- Thermocouple: JR type connector receptacle (ThermoC)
- **Multiplex connector 1**
- Battery input: Red/black cable
- Fuel pump: Red/Green cable
- **Multiplex connector 2**
- Glow plug: Red/Black cable
- Starter: Red/Blue cable

Note: In all power cables the black is the common and negative. This means that all the black cables are connected internally together and to the negative of the pump/starter battery.

Connect the cables in their places. Note that some of the JR type connectors used can be connected in wrong place or inverted. Use the colored labels on the **I.C.S.** body to connect all the connectors in their place. The configurations of the pins have done in the way that no damage can be produced to the electronics in the case of a bad connection.

Please note that:

- If the thermocouple connector is connected inverted, the temperature will decrease when heated, and the **I.C.S.** will fail in to recognize the gas ignition.
- If the RPM sensor is connected inverted, no RPM will be read.
- Use the recommended (supplied) starter motor battery or one of the same voltage. If you decide to use a battery with different voltage, the turbine ECU has to be readjusted at the factory.



I.C.S. Main Unit

Because the **I.C.S.** is an electronic piece of equipment, the installation in the model aircraft is similar to that of the radio receiver. It has to be in an accessible location within the airframe, with limited vibration and far from the heat of the engine. Also because the pump motor uses DC power, that can produce sparks in the collector when operating, it is highly recommended that the installation of all electrical equipment be done as far as possible from the R/C receiver. Keep the power cables at the minimum possible length and avoid installing the antenna near them.

3.2 Pump/Starter Battery

The **I.C.S.** needs for its operation two different power supplies. The first is taken from the radio receiver through the throttle servo connection and the second is the battery that supplies the pump. **Reversing the polarity of the battery causes the destruction of the semiconductors of the I.C.S.**

The **I.C.S.** can work with pump battery voltages between 1.2V and 15V in manual start mode, and from 4.8V to 15V in auto start mode. The selection of the number of battery elements is define considering the real needs of the ancillary equipment like starter motor, solenoids valves and pump motor. Use only the recommended battery voltage and capacity.

This battery does not need an on/off switch in the airframe since the **I.C.S.** has an internal electronic switch, which disconnects it when the power to the receiver is switched off.

The NiMh batteries are not recommended due to its high internal resistance.

Use good quality sintered fast-charge NiCad's for the ECU supply with at least 1200mAh, preferably 2000mAh, capacity and charge before each flight.

3.3 Radio Receiver

The **I.C.S.** is connected to the radio receiver like a standard throttle servo, inserted in the channel for the throttle, receiving the information of the throttle control pulses and the receiver battery supply. We recommend any 6V-regulated systems.

3.4 Thermocouple

The **I.C.S.** uses a thermocouple of type "K", good up to 1100°C. The provided standard thermocouple consists of an Ø1.5 mm diameter Inconel wire, finished with a connector that fits directly on the **I.C.S.** The recommended installation is by inserting the end of the thermocouple so that it is 2 mm, 1/16 inch, within the flow of exhausts gases; and plugging the lead into the **I.C.S.** at proper input. Take note that the wire coming from the thermo coupler has a solid green wire and a green and white wire. The input of the **I.C.S.** is color-coded; make sure to line up the correct colors when plugging in this lead.

Never bend or cut the probe or probe wires. If you need to extend the wire, use a servo extension.

3.5 Fuel Line

Note: the arrow on the pump shows the direction of the fuel flow.

Connect necessary length of 4mm tube in the suction side of the pump from the fuel supply, and the 4mm output line to the fuel solenoid valve. Place the manual on/off valve between the air trap and fuel pump **CLEAR** fuel input line. We recommend placing the MANUAL valve where it can be closed easily.

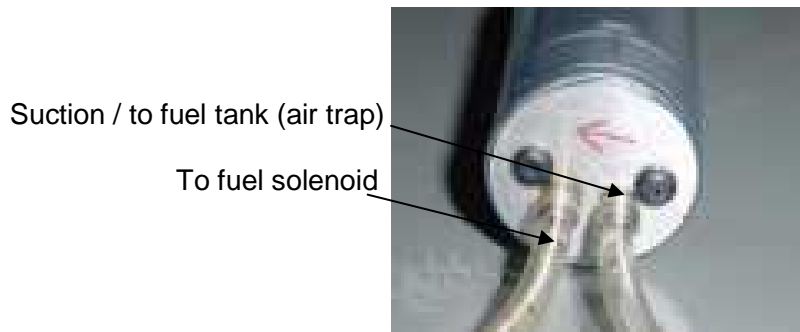
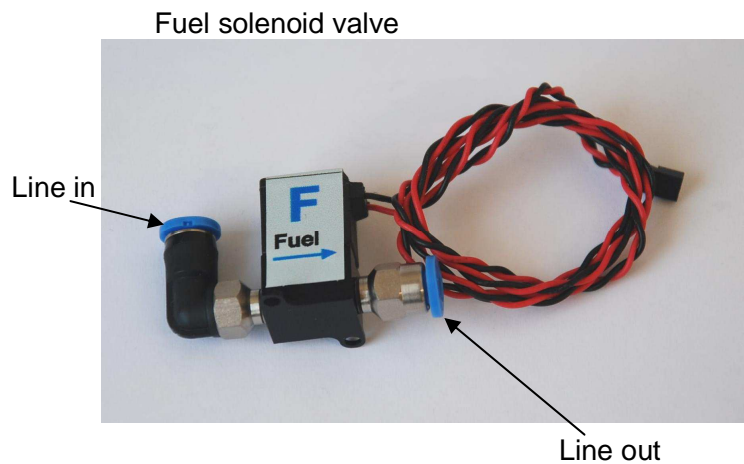

3.6 Starting gas

Connect necessary lengths of 4mm line to each side of the push in “T” fitting on the onboard start gas tank, to one side connect the One Way Festo fill valve, and to the other side connect the start gas solenoid. Connect the gas flow restrictor and Festo filter end, to the **YELLOW** 4mm gas line coming from the turbine. Then connect the filter to the output of the Gas solenoid.

TIP: use a pair of needle nose pliers inserted into the Festo line to open the pliers, this will stretch the line to easily fit over the barb fittings and the line will return to its normal size. DON'T use heating method, it will leak.

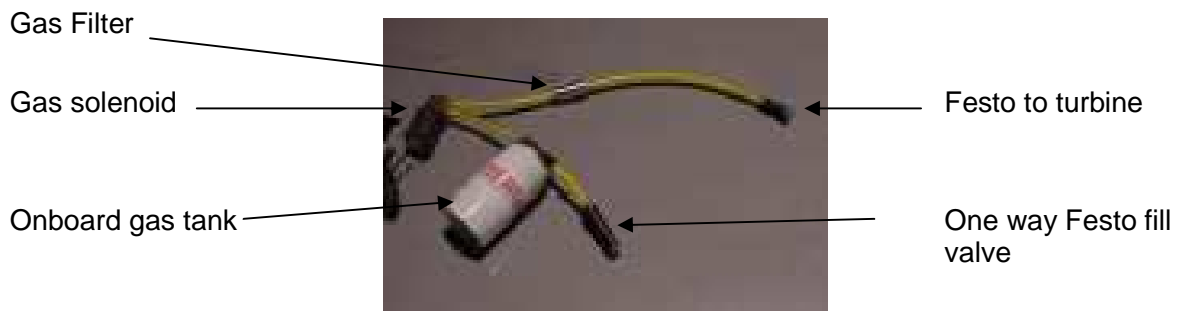

3.7 Rpm Sensor

Connect the JR line coming from the turbine to the rpm input on the **I.C.S.**

3.8 Turbine Service Lines Description

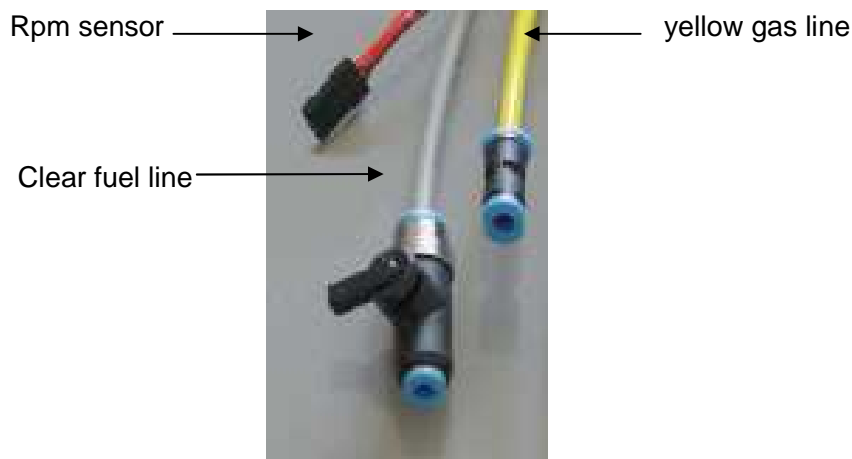

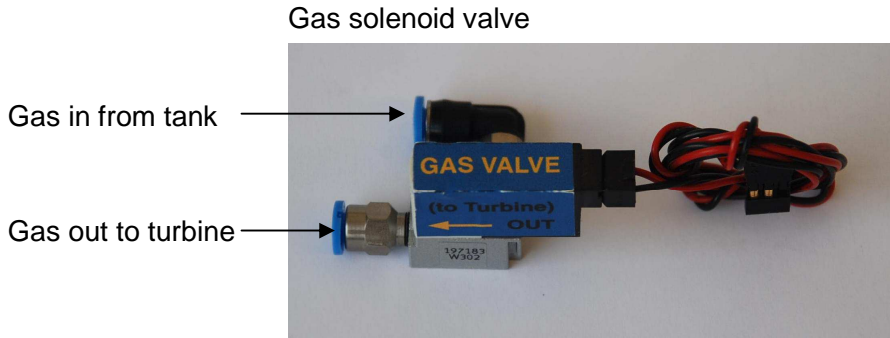

Make sure all plastic tubing is square and completely inside the Festo connectors. A slight twist while pushing in helps to make sure you are all the way in

Make sure all of the "end" cuts of the plastic tubing are clean, square and free of burrs before you connect.

Connect all the components as shown in the diagram below. This is important to the successful operation of your Artes Turbine.

Install the fuel tank(s), and air bubble trap system according to the manufactures instructions. This is also important to a successful experience.

Please double check the position of the fittings and valves as shown in the diagram below. Failure to properly install these components could lead to leaks or operation issues. Any leaks must be corrected prior to the operation of your Artes Turbine. Failure to do so could cause a fire, loss of aircraft and possible injury

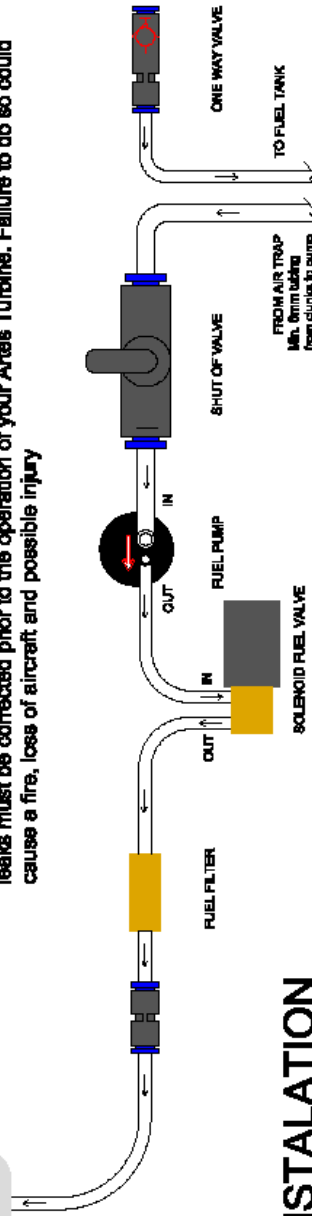
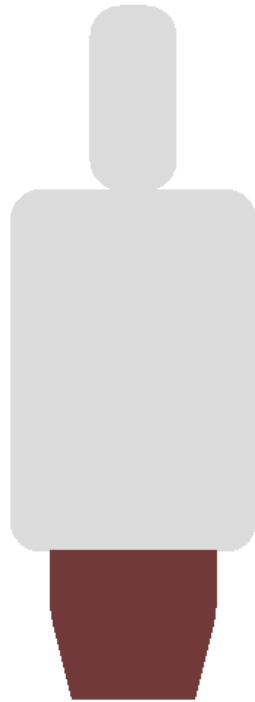

FUEL SYSTEM INSTALLATION

Make sure all plastic tubing's are completely inside the Festo connectors. Sometimes a slight twist while pushing in helps to make sure they seat properly.

Make sure all of the end cuts of the plastic tubing are clean, square and free of burrs prior to connecting.

Connect all components as indicated in the diagram below. This is important to the successful operation of your Artes Turbine.

Install the gas tank as close to vertical as possible. This ensures the proper flow of gas (Butane, Propane) or a mix (Powermax) during the start of your turbine.

Please check the position of valves, solenoid, gas filter and restrictor (look for a bulge in the line) as well as the Festo fittings for proper operation. Check for leaks in the system prior to starting your turbine. Failure to do so could cause a fire, loss of airplane and possible injury. Safety is your goal.

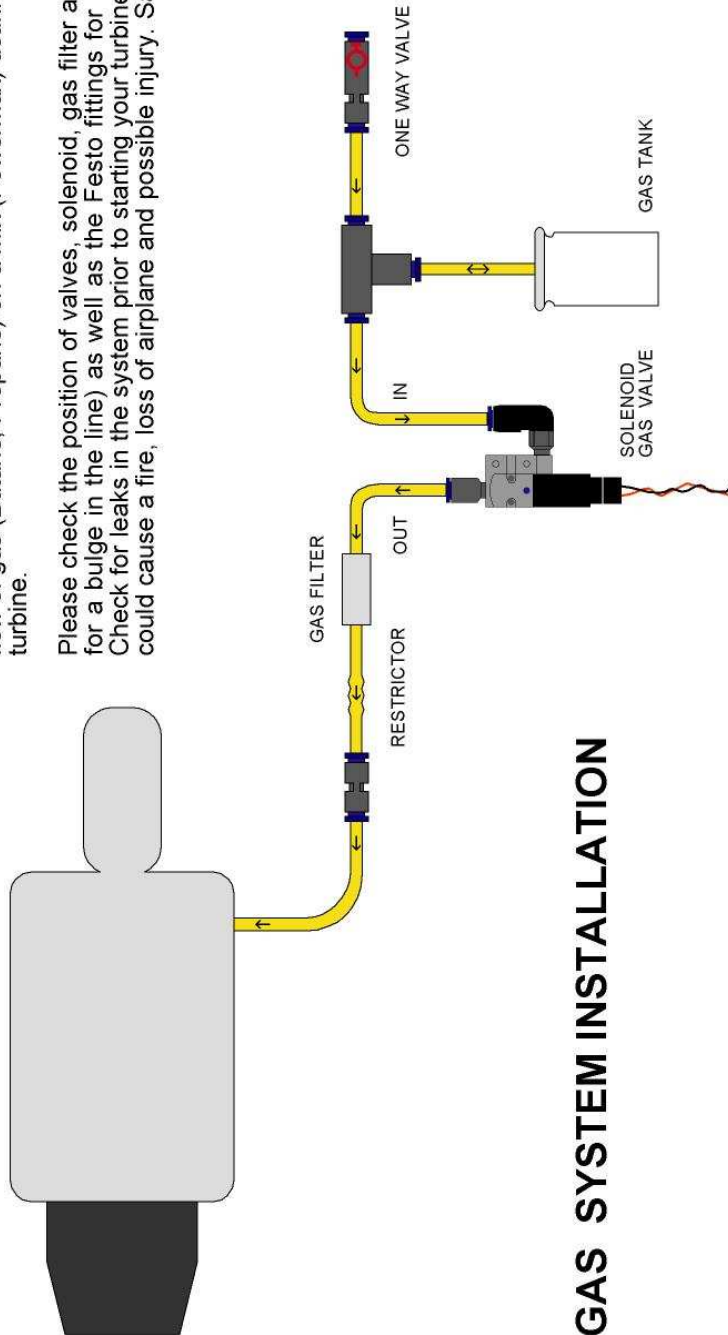

GAS SYSTEM INSTALLATION

ELECTRIC INSTALLATION DIAGRAM

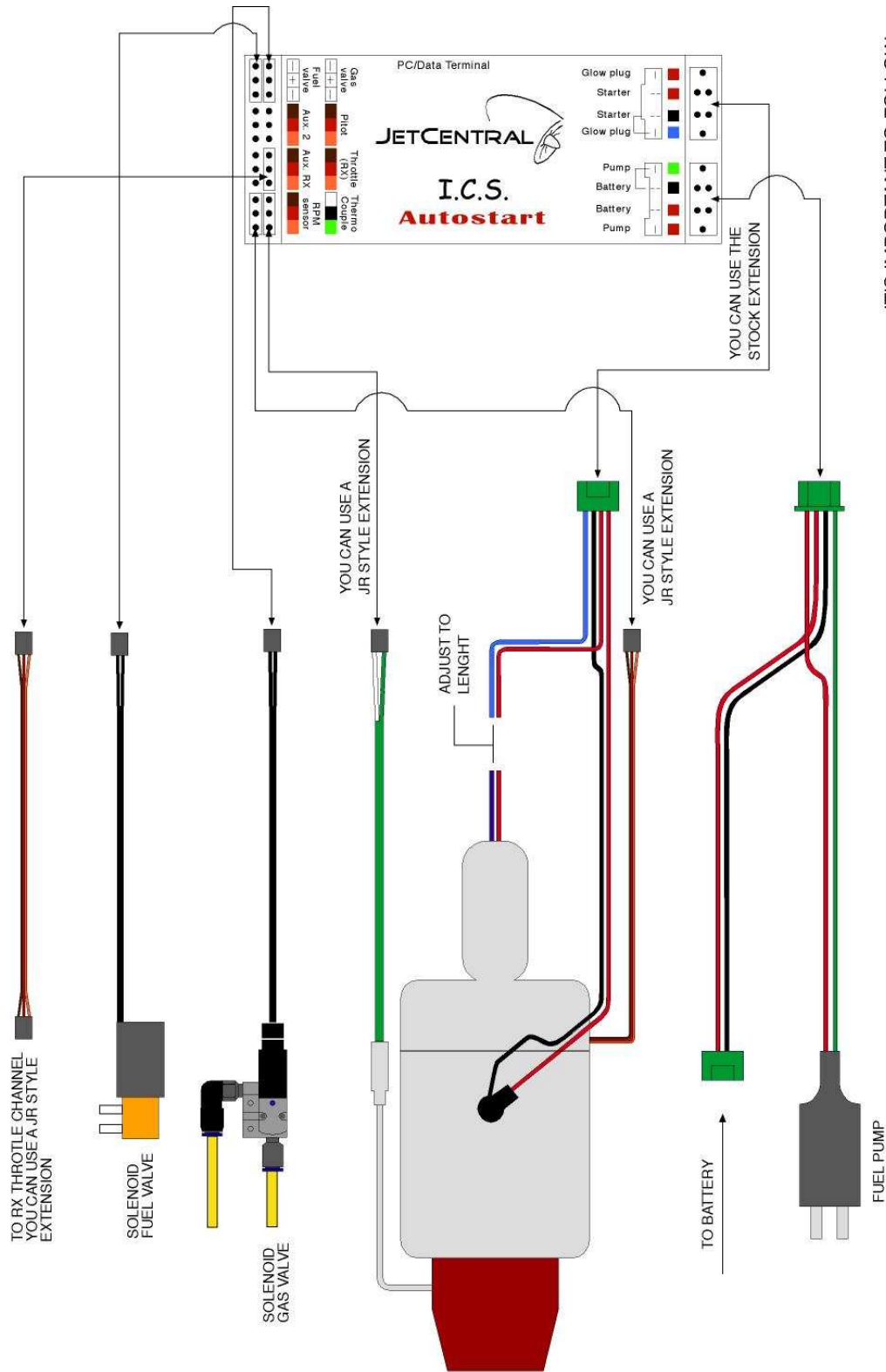

4 Programming the I.C.S.

The HDT has a LCD with 16 characters x 2 rows and four buttons which allow you to move through the various menus and to change the data settings in each menu page. The presentation of data has been organized in screens. The first two, displays the engine status readings in real time and the following screens allow you to modify the operating parameters. All of the parameters can be modified while the engine is running, so it is easy to tune the engine without having to start it again to test the new settings. Both left buttons allow you to move through the different screens in an ascending mode (Menu Up) or descending mode (Menu Down). Both right buttons allow you to change the data in increasing value (Up Data) or decreasing value (Down Data).

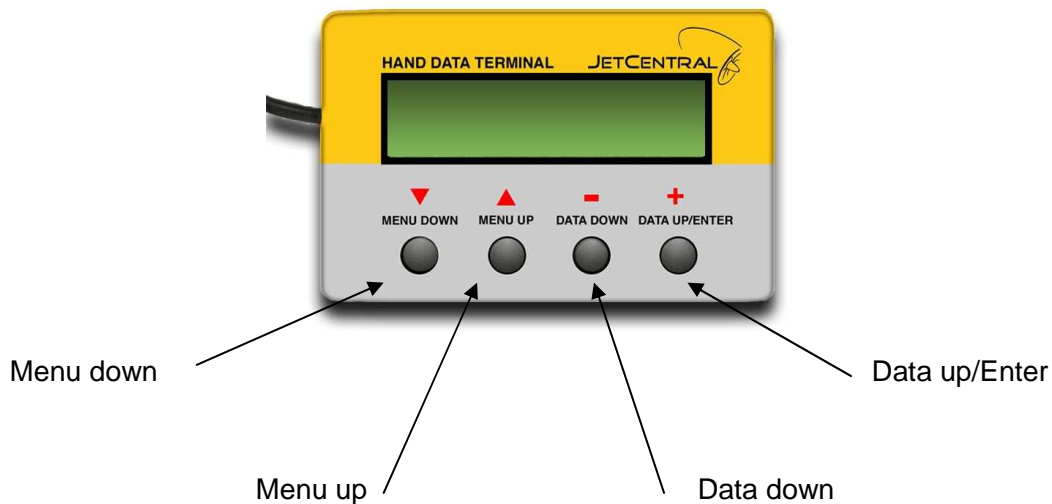

4.1 First Screen

When you have connected the I.C.S. and you turn on the RX, appears briefly the presentation screen with the Serial Number of your engine.



4.2 Main Screen

In this screen you have the status of the engine, temperature (Centigrades), RPM and the power

supplied to the fuel pump (PW). This goes from 0 to 999.

4.3 Secondary Screen

If you push the Menu Up button you get to the secondary screen.

Here you have the pulses from your transmitter, the % of the accelerator stick, the voltage of the I.C.S. battery and the software version.

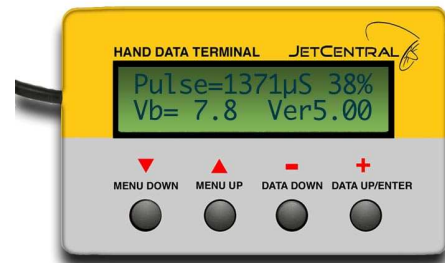

4.4 Menu Screen

By pushing again the Menu Up button you get to the menu screen.

Here you have four menus to choose from:

- Start
- Info
- Radio
- Run



To get into each menu, simply push the corresponding button.

Start – menu down (↓)

Info – menu up (↑)

Radio – data down (-)

Run – data up (+)

All the parameters in the submenus are factory preadjusted and they have a good starting point to fine tuning your engine. Make small changes at a time.

4.5 Start Submenu

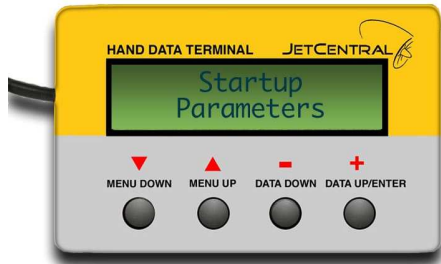

At the “Start” submenu you first get to this screen



Pushing the menu up button you get to “Glow plug power”

With the Data up and Data down buttons you can change this value. The idea is to have the lowest possible value, that can ignite your gas so your glow plug can last longer.



The next screen is “Start gas adjust”

Here you can change a little amount of the gas that goes to the turbine. Again, the goal here is to have the lowest possible gas but enough to have a reliable start all the time.



The last screen in the start submenu is the “Low batt adjust”.

If the voltage of the battery drops below this value, the start cycle will be interrupted

and you will get a “Low batt” alarm.

If you upgrade the I.C.S. battery mAh, you will may increase this value to become closer to the nominal battery voltage.

4.6 Info Submenu

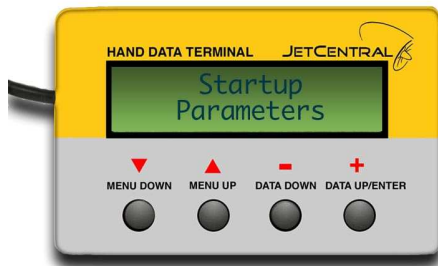

When you choose this option, the first screen will show the timers.

“Tot” – The total time in minutes that your turbine has run

“Last” – The time in seconds of your last run

“Cy” – The number of cycles (start, run, off) your turbine has

The second option is “Battery used”

Counts the mAh used from the battery. User can set to zero at first flight of the day, and check after each flight to know approximately the remaining power of the battery.

NOTE: The circuit that measures the amperage in the ECU is not a precision circuit, it was added to protect the ECU from overloads. Measured values can have an error of 10%.



Counter of bad RC pulses and total time duration of bad signal.



The next five options are test options. For these options you must have the trim down on your transmitter. They all have an ON (-) / OFF (+) button and you can test them individually: the Starter, Glow Plug, Fuel Pump, Gas Valve and Fuel Valve.



Starter



Glow Plug

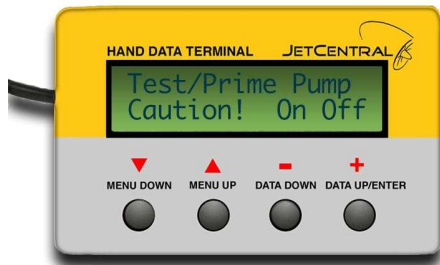

Fuel Pump



Gas Valve

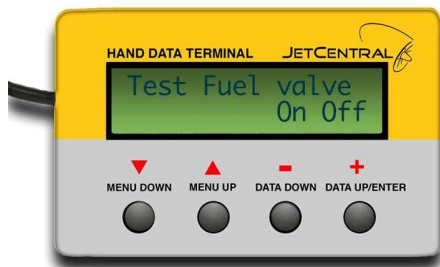

Fuel Valve

The priming procedure is by turning on the fuel pump until the fuel lines are full.

CAUTION: When you test the Fuel Pump you may flood the turbine.

4.7 Radio Submenu

IMPORTANT – Please Read

Before programming the **I.C.S.** to learn your transmitter throttle settings, it is important that you clear your transmitter of all and any **MIX** or **FAILSAFE** program you might have programmed connected to the throttle channel, this can interfere with the operation of the **I.C.S.**

Program your failsafe after you have programmed the **I.C.S.** to learn your transmitter throttle settings.

Here are some Key items not to forget to check:

- Your transmitters throttle channel atv, end points or travel adjustments should be at 100% with no reductions or mixes to it
- When your trim is down, HDT should read “Trim Low” and 0%
- When trim is up, HDT should read “Ready” and about 25%
- When you raise throttle to maximum, HDT should read 100%
- Always program your failsafe after you program your I.C.S. and set it to “ENGINE CUT” Throttle down and Trim Down
- Check that your failsafe is working properly

4.7.1 Transmitter Preparation and Verification.

First unplug the fuel pump/starter battery to prevent accidental starting of the engine.



The transmitter must not have programmed any reduction of throw, trim, slow movement, the center value or the linearity modified. In case of doubt it is recommended to connect a servo to verify that the movement is correct from end to end and fast. Once the transmitter is OK, connect the **I.C.S.** and by means of the key “Menu Up” change to screen 2. With the trim and stick of the transmitter raised (Full power) the reading of “Pulse = xxxx” must be between 1900-2200. With

stick and the trim lowered, the reading must be between 800 and 1200. In case readings are inverted, like in some Futaba transmitters, it is necessary to change the sense of the movement in the transmitter (Servo reverses). If the reading does not arrive at these values means that the transmitter has some function of limitation of throw applied to the throttle channel. Once verified the transmitter, the **I.C.S.** can be programmed.

In order to do it, move to the menu screen, press "radio" submenu and you get to the adjust screen.



This first menu is only informative and it warns you of the entrance in the screens of programming of the throttle control. Press the button 'Data Up' to enter in the programming menus. Next it appears the screen of programming the full throttle position.

In order to program these parameters locate the trim and stick in the superior position. Once located in this position, push the button "Data Up". At this moment the **I.C.S.** will record the received order of the radio as the position of full power and, in the HDT, the following phase of adjustment is shown. If this adjustment requires no modifications, is enough to push the key "Menu up". This also causes the change of screen but the throw is not programmed.

The following screen allows programming the lower limit (Stop). In order to do it is enough to locate the trim and stick to the minimum and push the button "Data Up". Also in this case pushing the button "Menu up" will cause the change of screen without varying the previous adjustment.



The last screen of adjustment is the position of the trim that will correspond to the idle of the engine. To make this adjustment it is sufficient locating the stick to the minimum and the trim to maximum and push the button "Data Up". Just as in the previous adjustments, the button "Menu up" will cause the change of screen without varying the last recorded adjustment.



Once finished the programming of the transmitter, it can be verified by means of the secondary screen of the HDT.

To the right of the value of the transmitter's received pulse appears one from 0 to 100%. This value must correspond to the relative position of the throttle stick, matching 0% to stick and the trim to the minimum and, 100% to stick and trim to the maximum. If these values were not

reached, or the limits of the 0 or 100% were reached before pushing the stick to the end, the calibration process must be repeated.

When the superior and inferior limits are verified, the adjustment of the trim can be verified. This is made through the green LED that incorporates the **I.C.S.**

With the **I.C.S.** in start mode, that is to say, just started, locating the trim and the stick at lower side the LED must be off. When raising the trim slowly, the LED must light approximately to half of the throw of the trim. From this point the **I.C.S.** considers that the motor must be running and below this, stopped.

4.7.2 Throttle Curves

By default the I.C.S. controls the RPM in linear way. I.E., at the half stick position the engine turns at half of the rotor RPM range. Jet engines develop the thrust in exponential mode, thus half RPM means approximately 1/4 of thrust. On small engines with a high idle to full power RPM ratio, or in a high drag/low power planes, often only the last 1/3 of the throttle stick produces significant thrust, with the low half stick travel being not used. Although that with current digital TX the pilot can modify the throttle curve to suit its needs, from version 5.48 three throttle curves have been added to simplify the setup for most of the installations:

FULL EXPO: Means linear RPM, it is the default setting and the mode used for all previous software versions. Thrust develops exponentially, and it is the recommended curve for big engines and/or high thrust/weight ratio planes, as it eases the control in low power used during taxi.

LINEAR: Means that the thrust develops linearly with the throttle settings. It could cause difficult taxi, as it would be difficult to fine adjust the power at low settings.

HALF EXPO: An intermediate setting between the other two modes.

	STICK POSITION					
MODE	0% (idle)	25%	50%	75%	100%	
FULL EXPO	Idle thrust	6%	25%	56%	100%	% of total thrust
HALF EXPO	Idle thrust	16%	38%	66%	100%	
LINEAR	Idle thrust	25%	50%	75%	100%	

4.8 Run Submenu



When you select this option you will enter the normal run parameter.

With menu up you get in the "Fuel power speed"

Here is where you can limit the RPM in order to get the thrust that you want.

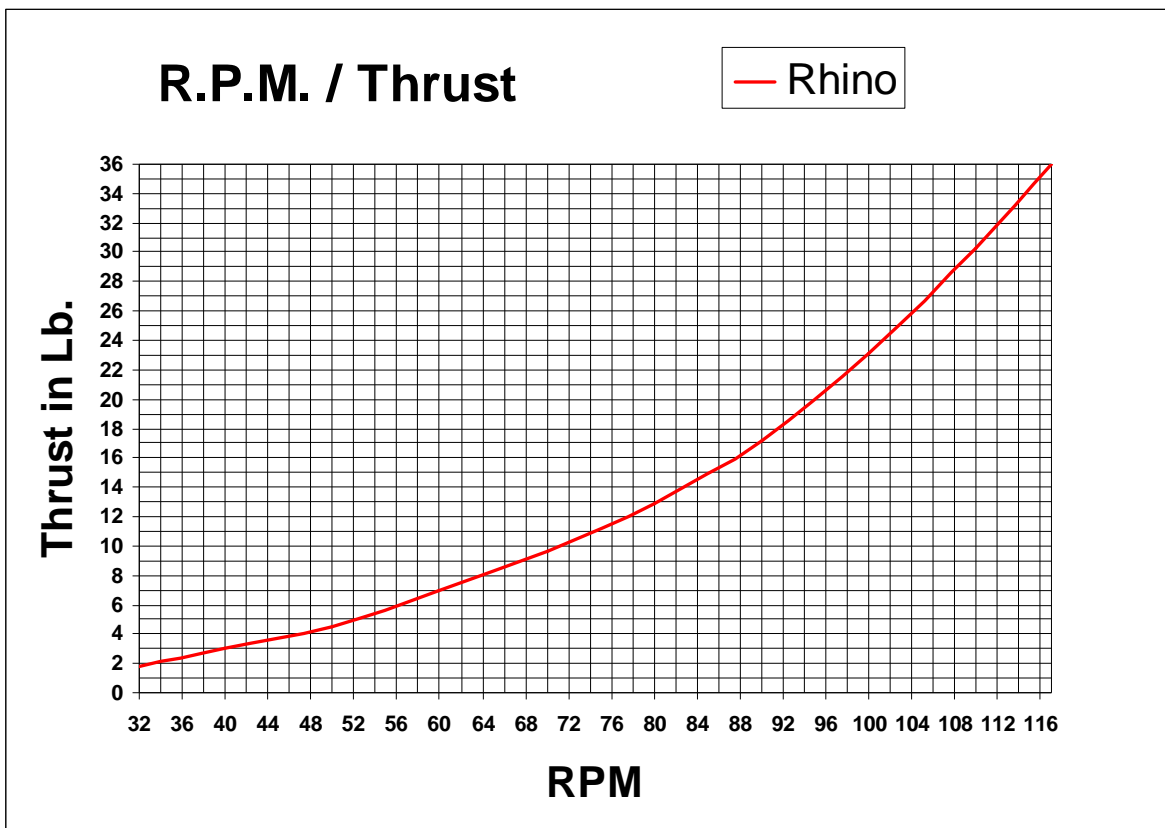

4.9 Last Run Shutdown Reason

To get to this screen you have to turn Off and turn On again the RX, then press the “Menu Down” and it will show for a couple of seconds the reason, temperature, RPM's and the power of the fuel pump.



- User Off – Means that was shutdown from the transmitter by a trim down or throttle cut
- Speed Low – Means that the I.C.S. registered a lower RPM than the minimum factory programmed
- Hi Temp – Means that the I.C.S. registered a temperature higher than the maximum factory programmed
- Low Temp – Means that the I.C.S. registered a temperature lower than the minimum factory programmed

All this data is very important to determinate the cause of the last shutdown or flame out.

In case this information is not enough to determinate the causes, the I.C.S. stores the last 51 minutes of use, and can be downloaded to a computer.

Please contact your dealer for advise.

5 Radio Link Failsafe

The **I.C.S.** has a failsafe feature that stops the engine in the case of the radio link failure, but prevents to stop it in the case of short glitches. This system works in PCM/PPM/IPD systems.

PPM systems

In the case of radio failure (erratic movement of the servos or pulses out of the programmed values window), the **I.C.S.** sets the power to idle during approximately 1 sec. If the radio link is regained in this time, the power goes back to normal, but if not the system will kill the engine.

PCM /IPD systems

The user should program the failsafe of these systems to cut the engine (trim low-stick low). In the case that the receiver has a radio link failure, it will output the failsafe settings. The **I.C.S.** will set the power at idle during 1 second after receiving the stop command, and if during this time the receiver exits from failsafe the engine will go back to the throttle set power. If not, it will be cut-off. This system allows flying through small glitches while retaining the ability to kill the engine in the case of radio failure.

ALWAYS PROGRAM THE FAILSAFE TO KILL THE ENGINE. NEVER FLY A TURBINE PLANE WITH THE FAILSAFE SET TO "HOLD".

Special features

Last power-down cause

The **I.C.S.** stores in its internal memory the measures of the engine each 0.5s up to 52 minutes. These measures are RPM, temperature, throttle position and pump power. Only can be downloaded through a PC and a RS232 cable, but the user can check through the HDT the cause of the last power down and the measures of the engine at the moment when the **I.C.S.** cut the engine. This feature is useful to track the cause of a flame out in flight. After power up, set the trim low and press the "Menu Down" button. The HDT will show the cause of the last shut down, and the EGT, RPM and pump power at this moment during 2 sec.

6 Advanced Programming

These parameters cannot be accessed without a special code.

The **I.C.S.** has the ability to automatically adjust the pump power to start it at the lowest possible speed, independently of the battery voltage and pump roughness. Also the user has the possibility to **adjust the minimum pump power manually.**

In some cases such as in high altitude uses, we can open up parameters that the user can adjust; the Acceleration and Deceleration delays these are quite useful in high altitude operation. We will only do this if we see a performance benefit can be obtained for the user and he or she understands how these parameters affect the engine performance. Please feel free to contact us if you are operating a motor higher than 6000ft msl for a long period of time.

AUTO pump mode:

The values of "Pump start point" from 0 to 8 are in AUTO mode. This means that the **I.C.S.** will adjust itself the pump power to start it slowly. The recommended value is AUTO+0, that makes the pump start at the minimum possible speed, but it is possible to start in a faster speed by selecting AUTO+1, AUTO+2 if needed.

Manual mode:

From values from 9 to 255 the power applied to the pump is fixed. It is necessary to test with the selected pump and battery the right value, to allow the pump turn at the minimum speed.

Adjustment of the "Pump start ramp" value:

This parameter adjusts the speed of the fuel increase during the "Fuel ramp" phase. Higher values mean a faster fuel flow increase. Increase this value if the engine takes too long to arrive to idle, and decrease it if the starts are too hot.

Adjustment of the values of speed of acceleration (Acceleration delay), deceleration (Deceleration delay), and stabilization (Stability delay)

Habitually these values do not need adjustment and the recommended values are useful to most of the engines, but with the purpose of being able to use the **I.C.S.** with any type of turbine they are included in the parameters.

Time of acceleration (Acceleration delay)

The **I.C.S.** calculates the speed of acceleration depending on the exhaust temperature, the current rotor speed and its parameter (Acceleration Delay); therefore, it is possible to modify the global time of acceleration modifying it. Higher values mean longer acceleration times.

Time of deceleration (Deceleration delay)

For the calculation of the speed of deceleration the **I.C.S.** considers the same parameters as in the acceleration, unless the fixed value is this other parameter. Higher values mean longer times.

Stability delay

Once the engine has reached approximately the power corresponding to the value of the throttle setting, the **I.C.S.** adjusts the fuel flow with the purpose of match the exact value of thrust. The speed what the I.C.S. make this adjustment can be programmed with this parameter. The habitual values vary between 40 and 60, depending on the time of programmed acceleration deceleration, the temperature and the inertia of the whole system including pump, engine, tubes, etc. If a too low time is programmed, the engine will not become stabilized and will be raising and lowering to the power when correcting the **I.C.S.** more quickly than the response time of the turbine. If the time is very long, the **I.C.S.** will take more time to adapt itself to the engine in case of change in the batteries, pump, etc.

7 Starting the engine

Before Start Checklist

- Charge Receiver Battery
- Charge **I.C.S.** Battery
- Prepare Fire Extinguisher
- Check Fuel Tank Vent Unobstructed
- Mix oil 2.5% Ratio
- Fill Tanks Check For Leaks
- Open Manual Shutoff Valve
- Fill Start Gas Tank
- Turn On Receiver Switch
- Place Model With Nose In Wind
- Activate Brakes
- Start

Shutdown Check List

- Turn Model Into Wind
- Activate Brakes and Stop Turbine
- Close Manual Fuel Shut Off Valve
- After Cool down (2 minutes) Turn Off Receiver Switch

Starting the engine

Keep the magnetic RPM pickup clear of stray magnetic sources such as fuel pump, solenoid valves, glow plug wire, or servos, as the magnetic field generated can upset the rpm reading.

Ensure your glow plug element is well “teased out” to ensure prompt gas ignition.

Gas supplied must be liquid gas; dip-tube liquid feed types are suitable, if your system doesn't have one, just hold the gas bottle upside down. Propane and Propane/Butane mixtures work well in temperate climates.

Problems lighting the gas are mostly related to plug element exposure, ensure the element is pulled clear so the gas can really “see” the element. It needs to glow bright yellow for good ignition, so adjust the “glow power” setting in the main menu as required.

Always set-up and confirm the operation of your Auto-start installation on the test stand, before installing into your model. Always use a pre start checklist.

The present version of Auto Start uses only one channel to all of the engine functions: To trigger the auto start cycle, the process is as follows: **TEMPERATURE MUST BE BELOW 100°C TO START**

The user raises the trim. "Ready" will appear on the HDT (Hand Data Terminal) screen when the engine is supposedly to be to idle. If the trim is on "stop" position, "Trim low" will be read on the HDT. If higher than idle, "Stick Lo!" will be read.

When "Ready" is displayed, the user raises the stick to full power and to idle again, the start sequence begins.

GLOW ON if the glow test fails, a "Glow Bad" message is displayed, and the red led blinks.

WAITS ONE SECOND TO ALLOW THE GLOW PLUG TO WARM UP

GAS ON AND STARTER ON AT LOW POWER

GAS IGNITES

GAS IGNITION DETECTED PREHEATING AND FUEL RAMP

When the max ignition RPM is reached and the ignition isn't detected the starter is switched off and the RPM decays repeating the cycle. Usually the lack of ignition is caused by the glow plug that doesn't have enough filaments exposed or too much gas. "Weak Gas" message on the HDT means not enough gas has entered the combustion chamber to support ignition.

When the thermocouple registers an increase of 50°C in temperature or it is higher than the "start/minimum temperature", it means that the ignition have occurred, the starter is switched on immediately at reduced power, increasing its power accordingly to the real rotor RPM.

At the same time the engine begins to accelerate at the "fuel ramp" values, depending on the real RPM. Once the engine reaches the factory preprogrammed RPM's the gas valve is closed, and when the RPM arrive at the predefined "starter off" value, the starter is switched off and the brake applied to it. The engine continues accelerating alone until the idle RPM are reached.

Always accelerate to full power. Slowly the first time you start the engine, to allow the I.C.S. learn the full power and idle limits. Do this every time you recharge your batteries.

SHUT DOWN

To shut down the motor at any time, close the throttle trim and the motor will stop and go into auto-cool until 100°C are reached. The motor will only go into auto-cool if the trim is lowered.

START RECAP!

- 1. Fill the gas tank.**
- 2. Open the manual fuel valve.**
- 3. Check the voltage on your I.C.S. battery.**
- 4. Raise the trim the HDT will read "Ready"**
- 5. Raise the throttle to full and back to idle engine starts... "If not it will go into auto-restart mode"**
- 6. Shut down... lower the trim**
- 7. If you wish not to start the motor lower the trim FIRST, then the throttle.**

8 Proper Range Checking

We recommend this version of proper range checking as written By JR Propo.

- Place model perpendicular.
- Program up-elevator Fail Safe.
- Remove antenna.
- Hold transmitter arms length.
- Walk backwards until elevator deflects **STOP** and mark position and measure, carefully count how many paces out you went.
- Re-program Fail Safe for engine to idle.
- Perform exact same test with motor running at 1/2 throttle. When engine goes to idle **STOP** and mark position, and carefully count how many paces you went.
- If you lost more than 20% with the motor running investigate and retest. JR Team Members like to see minimums of:
 - Engine off 175 Feet, 60 paces, 55 m.
 - Engine running 150 feet, 50 paces, 50 m.

DON'T FORGET AFTER THE ABOVE RANGE CHECK TO RESET YOUR FAILSAFE TO "ENGINE OFF" THROTTLE DOWN TRIM DOWN!

9 Fuel and Fuel System Care

Your **JET CENTRAL** micro turbine can burn deodorized kerosene-k, kerosene or Jet-A for fuel. Fuel must be mixed with **2.5%** synthetic turbine oil. Example formula: 16-Oz of oil in 5 Gallons of fuel.

Filtering

You may use an onboard filter if you wish. We use an automotive type filter and filter the fuel before it goes into the tank.

Header Tank

We recommend a header tank with some type of bubble eliminator or an Orbit clunk. This is a must do, if you want to take every possible measure to insure against flame outs

Fuel Line

We recommend to always safety tie all fuel line connections unless they are a Festo connect.

Tanks

Always use a gasoline compatible stopper; as for fuel tanks, Dubro style and Kevlar tanks work fine and seem to have the best impact resistance; but always use a 5/32 size brass tubing for pick up and vents, this ensures your fuel flow is always flowing without resistance.

10 Multiengine Installation

For multiengine installation, first set up each motor as per manual, start and run each engine separately. Then, when you are satisfied and your engines are starting and running smooth, plug the throttle leads from each of the **I.C.S.** into a “Y” connector and plug that into your throttle channel. Now both motors will start at the same time and shut down at the same time. This is preferred over individual starting and is a simple way of assuring you’re taking off on both motors!

Helpful Tips

- If one motor starts and the other doesn’t for any reason, just cycle the throttle again; the one not running will re-start.
- In multiengine installations always have each motor with its own complete fuel system.
- As ECU has auto restart, if you need to shut down after the motors are running and need to restart quickly, just raise the trim to the ready position and cycle the throttle, when the auto cool down cycle gets the motor to a safe temperature the ECU will restart the motors automatically.
- Place on/off switches on the throttle lead before the “Y” connector that plugs the ECU’s throttle channel into the receiver, this way you can shut off one motor or the other on the ground or start one at a time by turning off the engine desired, it is also helpful if you have a “BAD START” on one motor to reset the ECU.

11 Maintenance

Due to being an advanced design over other popular motors you will find that your **JET CENTRAL** turbine needs less maintenance and your turbine will only need to be properly cared for to get hours of enjoyment. We have new state of the art bearing systems, precision made combustion chambers and high efficiency turbine wheels that take heat and load of the main components thus greatly extending service requirements. If you find yourself needing service just call! We have a special system in place to give you quick turn around and for all major repairs your **JET CENTRAL** Turbine goes back to its ISO 9000 factory, were it was built to be repaired; this ensures a quick turn around with quality workmanship and keeps major repairs to the least cost.

12 Troubleshooting

PROBLEM	CAUSE	SOLUTION
When raising the trim of the radio, the LED is not illuminated	I.C.S. in stop mode after running.	Switch off and on the I.C.S. (RX) again.
	Bad adjustment of radio transmitter.	Program the parameters of the radio.
	Supply Failure.	Verify battery power, check connectors.
After cycling the throttle "Glow Bad" message appears	Blown glow plug or disconnected.	Check glow plug and battery.
After cycling throttle nothing happens and later the "Start Bad" message appears.	Start motor bad/disconnected.	Check starter.
After cycling throttle the rotor turns but later the "Start Bad" message appears.	Starter power to low.	Check starter battery.
	RPM sensor failure.	Check starter to run freely. Check RPM sensor connections.
The RPM are cycling but gas doesn't ignite.	Gas empty or gas solenoid valve disconnected or bad.	Check the Gas supply.
	Glow plug brightness to low.	Check/adjust glow plug brightness and filament is pulled out.
	Too much or not much gas.	Check restrictor clogged or missing.
When the gas is ignited the "Start Bad" Message appears.	The starter failed to have the minimum RPM to continue the sequence.	Check the starter Battery. Check the starter.
When the start gas is ignited the I.C.S. does not begin to pump fuel and "Time Out" message appears	The Temperature isn't hot enough to start the fuel ramp.	Check the temperature probe that it's inserted in the tail pipe 1/16".
	There is not much gas.	Check restrictor clogged or missing.
When the fuel ramp starts and the "Weak Gas" message appears	Gas does not ignite.	Check glow plug.
	The fuel is not reaching the engine.	Check fuel lines. Check manual valve is open. Prime an try again

I.C.S. SHUTDOWN CODES

The I.C.S. will always show you the reason of the last shut down. It will also give you a code and the engine parameters so you know why it has happened. Here are the codes and what they refer so it's important that in an unwanted shut down, note the given parameters and codes to see what has happened before restarting the turbine. These codes will be reset.

- **USER OFF** The I.C.S. has received the shut down command from the receiver
- **RX PWR** The I.C.S. lost power from the receiver
- **FAILSAFE** The I.C.S. received the failsafe command from the receiver
- **FLAME OUT** The I.C.S. lost the temperature reading from the thermocouple
- **SPEEDLOW** The I.C.S. has shut the turbine down due to the fact the RPM has fallen below a certain RPM
- **AUTOMODE** The I.C.S. has received a start command after initiated an auto start

IMPORTANT PARAMETERS - In each of the above codes also these important parameters will be displayed:

- **TEMPERATURE**
- **RPM**
- **PUMP POWER**

The I.C.S. stores at last 10 min run time parameters to help in diagnosing any issues.

13 IMPORTANT UPDATES

As the use of the **JET CENTRAL** motors increase, we find some important things to update the user. One every owner will receive a current update page as it is released.

1. **IMPORTANT** Use the supplied hangar 9 fuel filter just between the fuel pump and the turbine, this will insure you don't clog the oil flow reducer. If you don't use this filter you can damage the motor by reducing the flow of fuel/oil to the rear bearing!
2. Make sure to bring the trim to the lowest position to start the auto cool on the motor!
3. **IMPORTANT!** Use only 5 cell 6V packs on your receiver; this will insure proper operation of the turbine electronics. You can use a regulator if wished but we find 6V packs work just fine with today's radio equipment. Tests have proven that all turbine electronics can get glitches by lower 4.8 Volt packs running you radio system.
4. If its cold outside 65°F or below and you get a time out message this is due to the start gas flow not being enough, just leave your fill supply hooked up and open as you cycle the throttle to start. Then, once you get a pre-heat message or Ramp message, disconnect the fill bottle and let the engine finish the ramping just from the onboard gas tank.
5. If you experience any type of engine failure make sure to check the last power down cause and fix the issue. You do this by turning the receiver power switch off and on, wait until you get the main menu, then push and hold the menu down. The **I.C.S.** will tell you why the turbine was shut down and important parameters to verify. Don't try to restart the turbine again until you have wrote parameters down for future reference, they will be reset after the next run.
6. Charge your batteries properly and make sure your packs are no less than 2 flights low. You can go more if you wish, but it's a good habit to re-charge after every second flight.
7. **IT IS IMPORTANT IF YOU FLY ANOTHER BRAND OF TURBINE TO MAKE SURE YOU UNDERSTAND THE STARTING PROCEDURES OF THE JET CENTRAL I.C.S. ECU AND UNDERSTAND THE DIFFRACE.**

Programming the transmitter when the HDT asks for stick up and trim up, place the trim all the way to the top; then when the HDT asks for stick low trim at idle place the trim only to the center during this learn feature.

Follow the above steps and now if needed after your turbine is running you can use the seconded half of your trim movement to idle up your motor to create some residual thrust to help in taxing and for landing if wished.

14 ECU Learning Procedure

Learning Procedure after initial start of turbine

1. Start and let idle for at least 1 minute
2. Advance throttle one click at a time until reaching full throttle
3. Leave at full throttle until turbine reaches MAX RPM as pre set by factory (check under RUN Menu). This may take a minute or two.
4. Once reaching Max RPM, reduce throttle one click at a time pausing for 3-5 seconds at each click until you reach idle. Let idle then perform a smooth transition of throttle stick to full throttle. Checking to see Max RPM.

Enjoy your new Jet Central Turbine. Your Jet Central Team welcomes you aboard and thanks you for selecting our product for your new turbine.

15 WORLDWIDE SERVICE

USA

Jet Central USA

Eric Clapp
7162 Dogwood Court
North Port, Florida 34287
Office: 941-468-1246
Home: 941-423-9931
www.jetcentralusa.com
jetartessales@aol.com

Germany

RESCUE - Turbinen-Service (service only)

Uwe Kannapin Cordinger Str. 98
D – 29699 Bomlitz
www.ukpraezitec.de
uwekannapin@aol.com

Spain

Asoc. Cast.de Aerodelismo Turbin (Only Field Assistance)

Ramón Lozano Yuste
Av. del Puerto No. 252
Grao de Castellón, 12100
Tel. (34) 964 281331

México

Factory Direct

Juan Ramón Ruiz
Coltongo 158
02630 México D.F.
Tel. + (55) 5090 7477
www.jetcentral.com.mx
info@jetcentral.com.mx

Please take note of different time zones, as **JET CENTRAL** is a worldwide company.

JET CENTRAL **Lifetime Turbine Warranty** **For Jet Central Micro Turbines**

The Lifetime Limited Warranty coverage is provided on eligible turbines delivered to customers in all market areas. *Jet Central* will provide for repair or replacement of covered components of the turbine for life to the original owner in accordance with the following terms, conditions and limitations.

1. **Warranty Coverage.** Under the Limited Lifetime Warranty you are provided with coverage from the date of purchase (start date) provided you register your purchase with *Jet Central* within 15 days of purchase.
2. **Eligible Turbines.** 2006 model year turbines sold to eligible customers on or after October 1, 2006 in all market areas by *Jet Central* and/or its authorized dealers. Current eligible turbines are, but not limited to; jf50, Super Bee, jf80 Falcon, jf100 Super Eagle and jf170 Rhino
3. **Repairs Covered Under the Lifetime Limited Warranty.** *Jet Central* will repair, replace or adjust all covered components as specified on page 2 that fail due to defective material or workmanship or wear and tear resulting from defective material and workmanship during the applicable warranty period. Lifetime Warranty period is applicable to the original owner. Original owner must register their purchase with *Jet Central* within 15 days of purchase. There will be no exceptions to this rule.
4. **Component Protection.** Covers all components of the turbine with exception of Glow Plug. Components of the turbine are limited to specifically those parts when combined and assembled result in a complete turbine engine.
5. **Where to Go for Covered Repairs.** *Jet Central* recommends that you return your turbine to *Jet Central Micro Turbine Manufacturing* or notify your dealer for instructions which will expedite the return and repair of your turbine. If you require assistance in receiving covered repairs or locating the nearest authorized dealer or for specific instructions for return, you may call *Jet Central* or email *Jet Central* direct. Please see operator's manual for contact information for your specific area.
6. **Repairs.** All warranty repairs of covered components MUST be made with service parts or manufactured parts authorized by *Jet Central*. In some cases, the use of *Jet Central* remanufactured parts is at the discretion of *Jet Central*.
7. **Care of Turbine.** Your turbine must be properly operated and maintained in accordance with the operation manual received with each turbine. Recommended maintenance schedules must be adhered to. It is your responsibility to make sure that all scheduled maintenance is performed and materials used meet *Jet Centrals* specifications. Failure to have scheduled maintenance performed as specified in the operators manual by *Jet Central* will invalidate warranty coverage on parts affected by the lack of proper operation and maintenance. Turbine **must** be operated with a FOD screen.
8. **Transferability.** This warranty is transferable. If you sell your turbine, *Jet Centrals* Limited Lifetime Warranty may be transferred to the new owner.

New owner is required to pay a transfer fee of \$250.00 USD, register his name as the new customer who owns serial number _____ within 15 days of purchasing a pre-owned *Jet Central* Micro Turbine sold on or after October 1, 2006 to its original owner. No exceptions will be available.